

MS9500 Voyager™ Series

Single-Line Hand Held Laser Scanner

User's Guide

Disclaimer

Honeywell International Inc. ("HII") reserves the right to make changes in specifications and other information contained in this document without prior notice, and the reader should in all cases consult HII to determine whether any such changes have been made. The information in this publication does not represent a commitment on the part of HII.

HII shall not be liable for technical or editorial errors or omissions contained herein: nor for incidental or consequential damages resulting from the furnishing, performance, or use of this manual.

This document contains propriety information that is protected by copyright. All rights reserved. No part of this document may be photocopied, reproduced, or translated into another language without the prior written consent of HII.

© 2000-2013 Honeywell International Inc. All rights reserved.

Web Address: www.honeywellaidc.com

Trademarks

Voyager, VoyagerCG, MetroSelect, MetroSet, and CodeGate are a trademarks or registered trademarks of Metrologic Instruments, Inc. in the United States and/or other countries.

Microsoft, Windows, and Windows 95 are trademarks or registered trademarks of Microsoft Corporation.

IBM is a trademark of International Business Machines Corporation.

Other product names mentioned in this manual may be trademarks or registered trademarks of their respective companies and are the property of their respective owners.

Patents

For patent information, please refer to www.honeywellaidc.com/Patents.

TABLE OF CONTENTS

Introduction

Product Overview	1
Scanner and Accessories.....	2
Scanner Components.....	4
The PowerLink Cable	
Disconnecting.....	5
Connecting	5
Labels.....	6
Maintenance.....	6

Installing the Scanner to the Host System

RS232, Laser Emulation, and Light Pen Emulation.....	7
RS485	8
Keyboard Wedge.....	9
Stand-Alone Keyboard	10
Integrated USB	
Full Speed	11
Low Speed	11

The MS9540 VoyagerCG Series

How to Use CodeGate and the Manual Activation Mode	12
Three Modes of Operation.....	12

Stand Kits

Types.....	13
Assembly.....	14

Indicators

Audible	17
Visual.....	18
Failure Modes.....	19

Configuration Modes	20
---------------------------	----

Upgrading the Firmware	23
------------------------------	----

Depth of Field.....	24
---------------------	----

TABLE OF CONTENTS

IR Activation Range.....	25
Applications and Protocols	26
Troubleshooting Guide	27
Design Specifications	
Operational.....	30
Mechanical	31
Electrical.....	31
Environmental	31
Scanner and Cable Terminations	
Scanner Pinout Connections	32
Cable Connector Configurations	34
Limited Warranty	36
Regulatory Compliance	
Safety	37
EMC	38
Index.....	40
Customer Support	42
Technical Assistance.....	42
Product Service and Repair.....	42

INTRODUCTION

Product Overview

Honeywell's MS9500 Voyager™ series of hand-held (single-line) laser scanners offers the user an aggressive solution for scanning all standard 1D bar codes including GS1 DataBar™ (RSS) bar codes. The MS9500 series is equipped with both *in-stand* and *out-of-stand* operation enabling hand-held or fixed projection scanning. The MS9520 Voyager model includes all of the same features as the MS9540 VoyagerCG™ model, with the exception of Honeywell's patented CodeGate™ technology.

The MS9540, VoyagerCG incorporates Honeywell's patented auto-trigger and CodeGate button feature. When a bar code is placed in the scanner's IR range, the auto-trigger activates the laser enabling the user to align the visible laser line over the bar code selected for scanning. The user can then press the CodeGate button, to transmit the data to the host system. When the MS9540 is placed in the stand the CodeGate button feature will automatically deactivate for hands free operation.

Some additional key product features for the MS9500 series include:

- Auto-trigger operation and auto-stand detect
- CodeGate data transmission technology (MS9540 only)
- Flash – upgradeable firmware
- Easy configuration with MetroSelect™ bar codes and MetroSet™ 2 Windows® compatible software
- Support for common interfaces including USB (see chart below)

VOYAGER	VOYAGERCG	INTERFACE
MS9520 – 00	MS9540 – 00	Laser Emulation RS232 Transmit/Receive
MS9520 – 11	MS9540 – 11	RS485 [◆] , RS232 (TXD, RXD, RTS, CTS)
MS9520 – 14	MS9540 – 14	RS232 (TXD, RXD, RTS, CTS, DTR, DSR)
MS9520 – 38	MS9540 – 38	Low Speed USB*, TTL RS232 (TXD, RXD, RTS, CTS)
MS9520 – 40	MS9540 – 40	Full Speed USB, RS232 (TXD, RXD, RTS, CTS)
MS9520 – 41	MS9540 – 41	RS232/Light Pen Emulation
MS9520 – 47	MS9540 – 47	Keyboard Wedge, Stand-Alone Keyboard and TTL RS232 Transmit/Receive

* Configurable for Keyboard Emulation Mode or Serial Emulation Mode. The default setting is Keyboard Emulation Mode.

◆ Applicable for IBM® host applications.

INTRODUCTION

Scanner and Accessories

BASIC KIT	
Part #	Description
MS9520 or MS9540	Voyager Bar Code Scanner or VoyagerCG Bar Code Scanner with CodeGate
00-02544	MetroSelect Single-Line Configuration Guide*
00-02410	MS9500 Voyager Series Single-Line Hand Held Laser Scanner User's Guide*

* Available for download at - www.honeywellaidc.com

OPTIONAL ACCESSORIES	
Part #	Description
AC to DC Power Transformer - Regulated 5.2VDC @ 1A output.	
46-00525	90VAC to 255VAC, United States, Canada and Japan
46-00526	90VAC to 255VAC, Continental European
46-00527	90VAC to 255VAC, United Kingdom
46-00528	90VAC to 255VAC, Australia
46-00529	90VAC to 255VAC, China
<hr/>	
53-53000.x-3	RS232 PowerLink Cable with Built in Power Jack Black, <i>Coiled</i> Cord, with Long Strain Relief
59-59000.x-3	RS232 PowerLink Cable with Built in Power Jack Black, <i>Straight</i> cord, with Short Strain Relief
53-53002.x-3	Keyboard Wedge PowerLink Cable with Adapter Cable <i>Black, Coiled</i> cord, with Long Strain Relief
53-53020.x-3	Stand Alone Keyboard Wedge PowerLink Cable <i>Black, Coiled</i> cord, with Long Strain Relief

Other items may be ordered for the specific protocol being used. To order additional items, contact the dealer, distributor or a customer service representative.

Scanner and Accessories

OPTIONAL ACCESSORIES	
Part #	Description
53-53213.x-N-3	USB Full Speed Cable Locking Plus-Power™ Type A, Black, Coiled Cord with Long Strain Relief
53-53214.x-N-3	USB Full Speed Cable Locking Plus-Power™ Type A, Black, Coiled Cord with Long Strain Relief, Extended Length  <i>Not for use with Low Speed USB scanners. Use with Full Speed USB scanners only.</i>
53-53235.x-N-3	USB Low Speed Communication Cable, Type A Black, Coiled Cord with Long Strain Relief
MVC**	RS485 MVC Cable ±12VDC to +5.2VDC
** <i>Contact a customer service representative for additional information on the MVC converter cable series and the host connections available.</i>	
46-46128	Free-Standing Stand with Accessories
46-46351	Hard Mount Accessory Kit (<i>used with kit #46-46128</i>)
46-46508	Wall Mount Hanger Accessory Kit

Other items may be ordered for the specific protocol being used. To order additional items, contact the dealer, distributor or a customer service representative.

Scanner Components

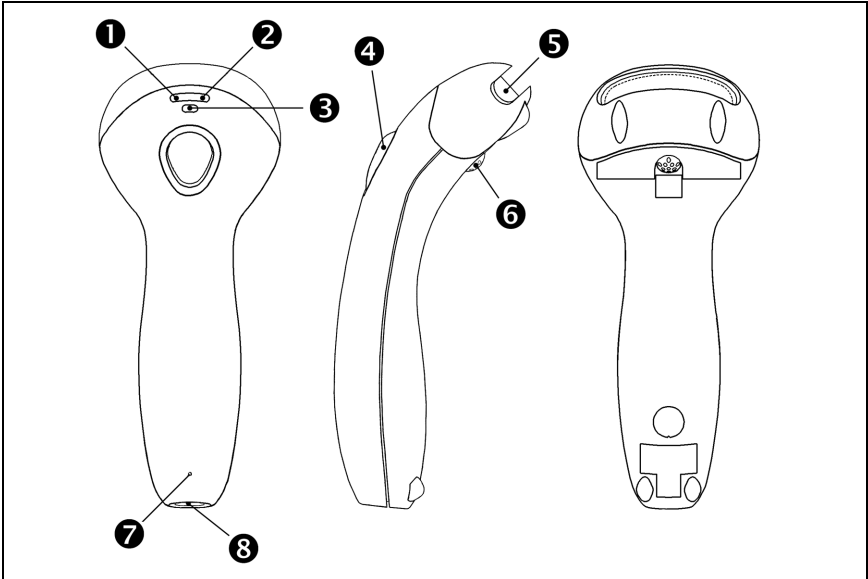

No.	Item Description	
1	Green LED [♦]	See <i>Visual Indicators</i> on page 18
2	Red LED [♦]	See <i>Visual Indicators</i> on page 18
3	Yellow LED ^{**}	See <i>Visual Indicators</i> on page 18
4	Button ^{**}	See <i>How to use CodeGate</i> on page 12
5	Red Window	Laser Aperture
6	Speaker	See <i>Audible Indicators</i> on page 17
7	Cable Release Pin-Hole	See <i>The PowerLink Cable</i> on page 5
8	Cable Connection	10-pin RJ45, Female Socket, See <i>Scanner Pinout Connections</i> on page 32

Figure 1. Scanner Components

[♦] In some custom units the standard green LED has been replaced with a blue LED and the red LED has been replaced with a white LED.

^{**} Items are provided with the MS9540, VoyagerCG model only.

Disconnecting the PowerLink Cable

Before removing the cable from the scanner, Honeywell recommends that the power on the host system is off and the power supply has been disconnected from the PowerLink cable.

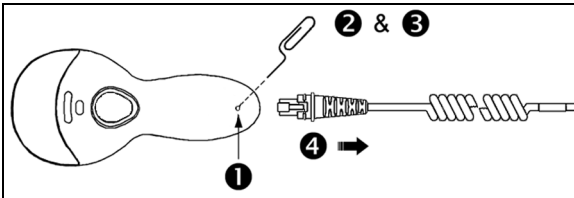

Figure 2.

1. Locate the small 'pin-hole' on the top of the unit near the bottom of the scanner.
2. Bend an ordinary paperclip into the shape shown above.
3. Insert the paperclip (or other small metallic pin) into the small 'pin-hole'.
4. There will be an audible *click* when the connector lock releases. Pull gently on the strain-relief of the PowerLink cable to separate the cable from the scanner.

Connecting the PowerLink Cable

i Important: If the PowerLink cable is not fully latched, the unit can power intermittently.

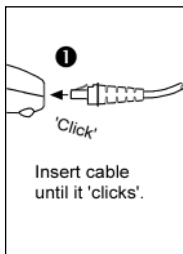

Figure 3.

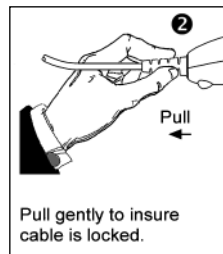

Figure 4.

INTRODUCTION

Labels

Every scanner has labels and molded text located on the underside of the unit. The labels and text contain important information such as the unit's date of manufacture, serial number, CE and caution information. Figure 5 provides examples of the labels and the molded text.

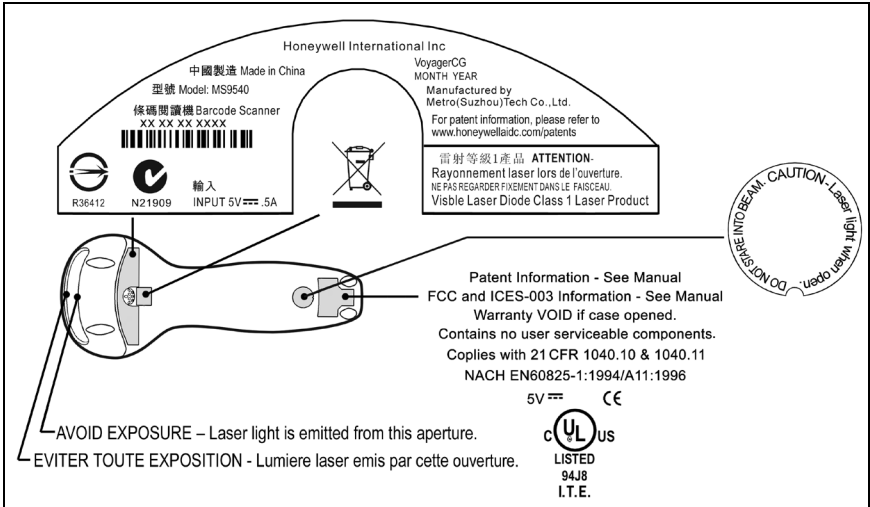



Figure 5 . Molded Text and Label Examples

Caution:
To maintain compliance with applicable standards, all circuits connected to the scanner must meet the requirements for SELV (Safety Extra Low Voltage) according to EN/IEC 60950-1.

 To maintain compliance with standard CSA-C22.2 No. 60950-1/UL 60950-1 and norm EN/IEC 60950-1, the power source should meet applicable performance requirements for a limited power source.

Maintenance

Smudges and dirt on the unit's window can interfere with the unit's performance. If the window requires cleaning, use only a mild glass cleaner containing no ammonia. When cleaning the window, spray the cleaner onto a lint free, non-abrasive cleaning cloth then gently wipe the window clean.

If the unit's case requires cleaning, use a mild cleaning agent that does not contain strong oxidizing chemicals. Strong cleaning agents may discolor or damage the unit's exterior.

INSTALLING THE SCANNER TO THE HOST SYSTEM

RS232, Laser Emulation, and Light Pen Emulation

1. Turn off the host system.
2. Connect the 10-pin RJ45 male connector into the jack on the scanner. There will be an audible *click* when the connector lock engages.



If the scanner is receiving power from the host system, skip to step #5.

3. Connect the L-shaped plug of the power supply into the power jack on the PowerLink cable.
4. Verify the AC input requirements of the power supply match the AC outlet. Connect the power supply into an AC outlet. The outlet should be near the equipment and easily accessible.
5. Connect the PowerLink cable to the proper port on the host system.
6. Turn on the host system.

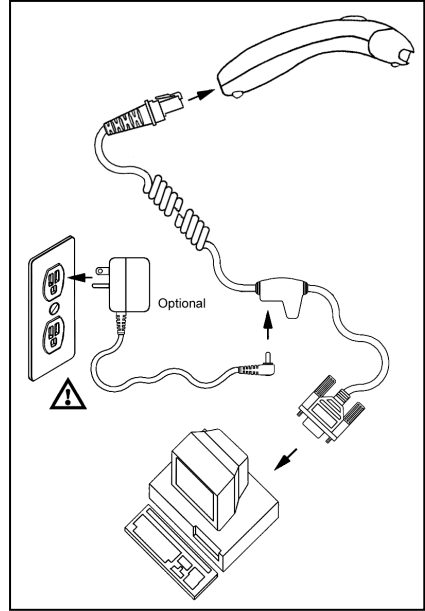

Figure 6.



Plugging the scanner into a port on the host system does not guarantee that scanned information will be communicated properly to the host system. Please refer to the MetroSelect Single-Line Configuration Guide or MetroSet2's help files for instructions on changing the scanner's factory default configuration. The scanner and host system must use the same communication protocols.



All MS95x0-00 scanners leave the factory with the *Laser Emulation Mode* enabled. If you *recall defaults* while re-configuring your scanner the *Laser Emulation Mode* will no longer be enabled. Refer to the *MS95x0-00 Laser Emulation Mode* section of the MetroSelect Single-Line Configuration Guide for information on enabling the *Laser Emulation Mode*.



See caution on page 6.

INSTALLING THE SCANNER TO THE HOST SYSTEM

RS485

1. Turn off the host system.
2. Plug the male 10-pin RJ45 end of the MVC cable into the 10-pin socket on the scanner. There will be an audible *click* when the connection is made.
3. Connect the other end of the MVC cable to the host device.
4. Turn on the host system.

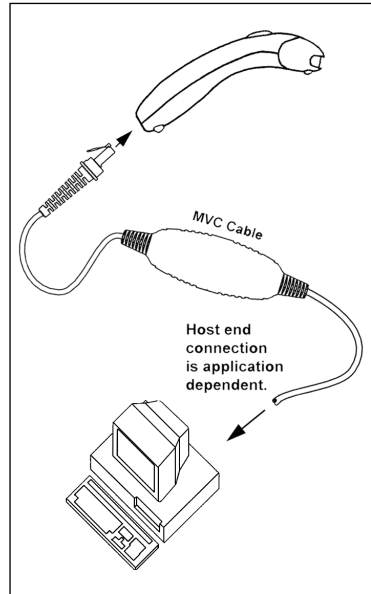

Figure 7.



Plugging the scanner into a port on the host system does not guarantee that scanned information will be communicated properly to the host system. Please refer to the MetroSelect Single-Line Configuration Guide or MetroSet2's help files for instructions on changing the scanner's factory default configuration. The scanner and host system must use the same communication protocols.



See caution on page 6.

INSTALLING THE SCANNER TO THE HOST SYSTEM

Keyboard Wedge

1. Turn off the host system.
2. Connect the 10-pin RJ45 male connector into the jack on the scanner. There will be an audible *click* when the connection is made.



If the scanner is receiving power from the host system, skip to step #5.

3. Connect the L-shaped plug of the power supply into the power jack on the PowerLink cable.
4. Verify the AC input requirements of the power supply match the AC outlet. Connect the power supply into an AC outlet. The outlet should be near the equipment and easily accessible.
5. Disconnect the keyboard from the PC.
6. Connect the PowerLink cable to the keyboard and the PC's keyboard port. If necessary use the supplied adapter cable (5-pin male DIN to 6-pin female mini DIN adapter).

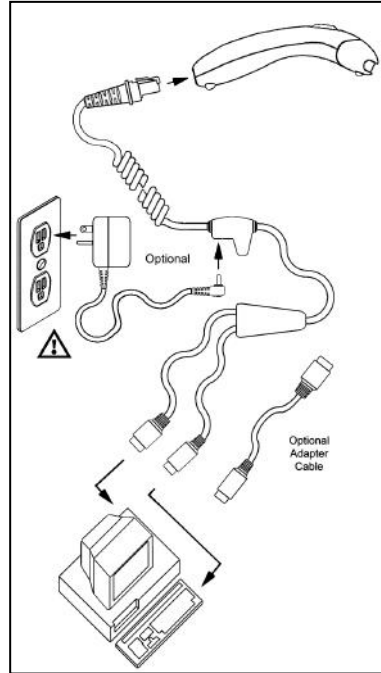

Figure 8.

7. Power up the host system.



Plugging the scanner into a port on the host system does not guarantee that scanned information will be communicated properly to the host system. Please refer to the MetroSelect Single-Line Configuration Guide or MetroSet2's help files for instructions on changing the scanner's factory default configuration. The scanner and host system must use the same communication protocols.



Powering the MS95x0-47 directly from the computer can sometimes cause interference with the operation of the scanner or the computer. Not all computers supply the same current through the keyboard port, explaining why a scanner may work on one computer and not another. Contact a Customer Service Representative if you require an external power supply.



See caution on page 6.

INSTALLING THE SCANNER TO THE HOST SYSTEM

Stand-Alone Keyboard

1. Turn off the host system.
2. Connect the 10-pin RJ45 male connector into the jack on the scanner. There will be an audible *click* when the connection is made.



If the scanner is receiving power from the host system, skip to step #5.

3. Connect the L-shaped plug of the power supply into the power jack on the PowerLink cable.
4. Verify the AC input requirements of the power supply match the AC outlet. Connect the power supply into an AC outlet. The outlet should be near the equipment and easily accessible.
5. Connect the PowerLink cable to the keyboard port on the host system.
6. Turn on the host system.

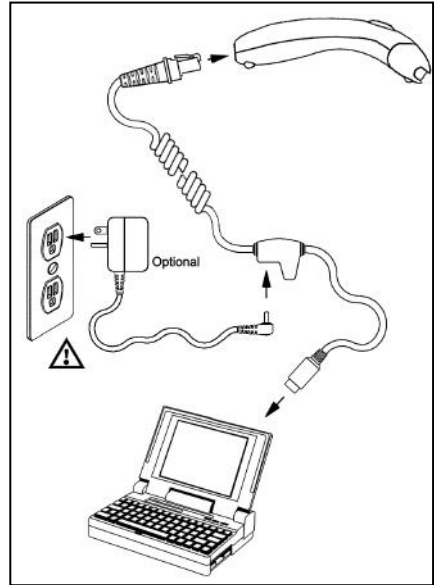

Figure 9.



Powering the MS95.x0-47 directly from the computer can sometimes cause interference with the operation of the scanner or the computer. Not all computers supply the same current through the keyboard port, explaining why a scanner would work on one computer and not another. Contact a Customer Service Representative if you require an external power supply.



Plugging the scanner into a port on the host system does not guarantee that scanned information will be communicated properly to the host system. Please refer to the MetroSelect Single-Line Configuration Guide or MetroSet2's help files for instructions on changing the scanner's factory default configuration. The scanner and host system must use the same communication protocols.



See caution on page 6.

INSTALLING THE SCANNER TO THE HOST SYSTEM

Integrated USB: Full Speed (-40) Low Speed (-38)

1. Turn off the host system.
2. Connect the 10-pin RJ45 male connector of the USB cable into the jack on the scanner. There will be an audible *click* when the connection is made.
3. Connect the other end of the USB cable to the host USB port.
4. Turn on the host system.

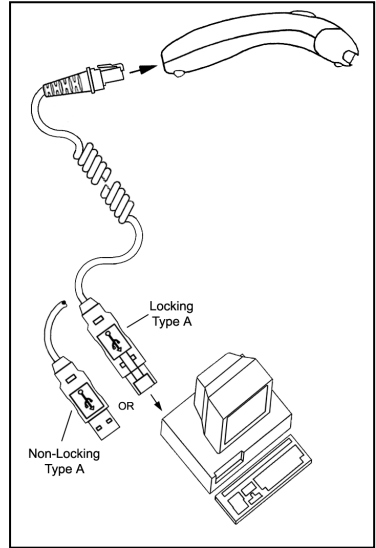

Figure 10.



As a default, the MS95.x0-38 leaves the factory with USB Keyboard Emulation Mode enabled.

For information on configuring the MS95.x0-38 for USB Serial Emulation Mode, please refer to the USB section of the MetroSelect Single-Line Configuration Guide (PN 00-02544).



Plugging the scanner into a port on the host system does not guarantee that scanned information will be communicated properly to the host system. Please refer to the MetroSelect Single-Line Configuration Guide or MetroSet2's help files for instructions on changing the scanner's factory default configuration. The scanner and host system must use the same communication protocols.



See caution on page 6.

How to Use CodeGate and the Manual Activation Mode

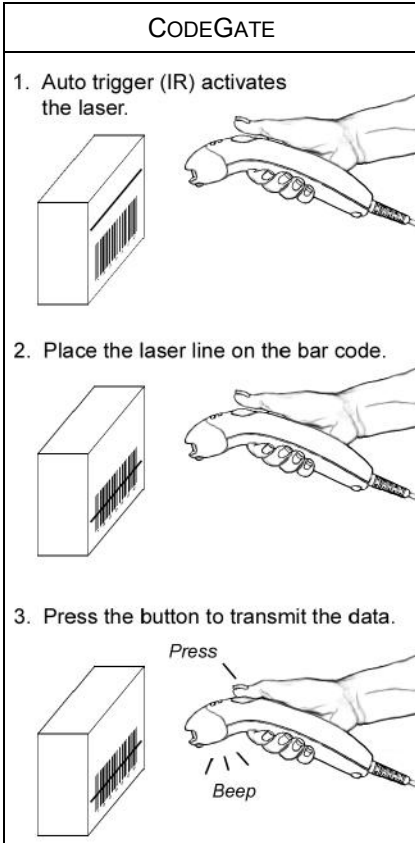

Figure 11.

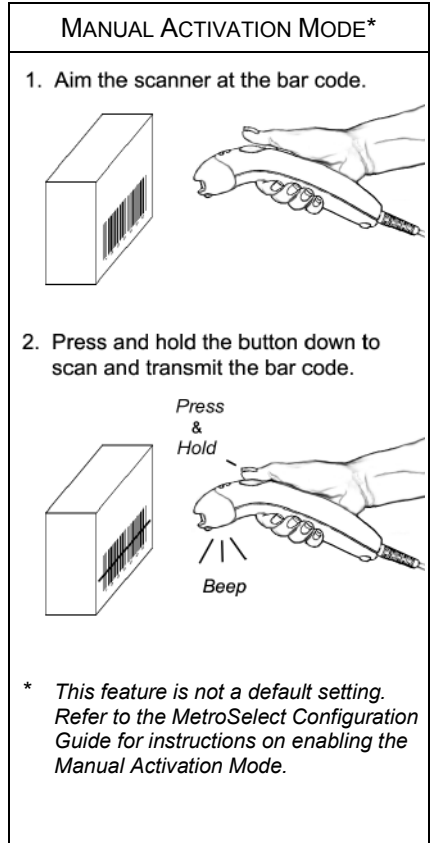

Figure 12.

Three Modes of Operation

Auto Trigger, In-Stand

- Auto-triggers while in the stand
- Bar code is automatically decoded and transmitted

CodeGate, Out-of-Stand

- CodeGate activates when removed from the stand
- Bar code data is transmitted when the button is pressed

Manual Activation Mode*, Out-of-Stand

- Button activates laser
- Bar code data is scanned and transmitted while button is held down

STAND KITS

Types

Free Standing Kit #46-46128

(Figure 13)

Kit Contains:

- a. Stand..... Qty. 1
- b. Apron Qty. 1
- c. Screw, M3 x 6 mm..... Qty. 2
- d. Washer, #5 x .5 OD Qty. 2
- e. Stand Anchor..... Qty. 1
- f. M3 x 20 mm Set Screw..... Qty. 1

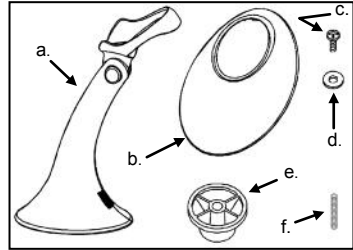

Figure 13.

Optional

Hard Mount Accessory Kit #46-46351

(Figure 14)

This kit, used in conjunction with the stand kit (#46-46128), can be used to hard mount (bolt) the MS9500 to the countertop.

Kit Contains:

- a. Screw, #8 Round Head Qty. 4
- b. Base Qty. 1

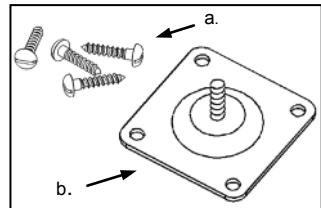

Figure 14.

Optional

Wall Mount Hanger Accessory Kit #46-46433

(Figure 15)

Kit Contains:

- a. Screw #8 Round Head Qty. 2
- b. Wall Mount Hanger..... Qty. 1

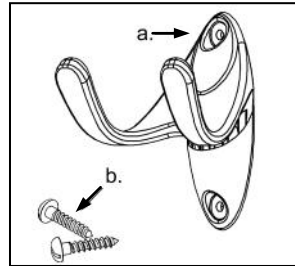

Figure 15.

Optional

Wall Mount Hanger Kit #46-46508

(Figure 16)

Kit Contains:

- a. Wall Mount Hanger..... Qty. 1
- b. Wall Mount Base Qty. 1
- c. 4.8 x 13 mm, Self Tapping Screw Qty. 2
- d. Double-Sided Adhesive Tape Qty. 1
- e. #8 Wood Screw..... Qty. 2

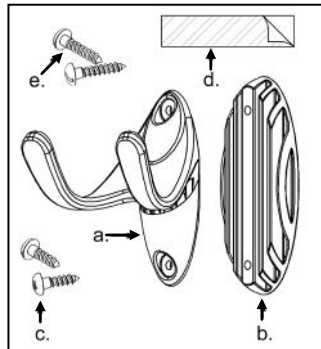

Figure 16.

STAND KITS

Assembly

There are two options for assembling the stand. The first option is a self-supporting stand that can be moved freely about on the countertop. The second option is used if the stand will be bolted or hard-mounted to the countertop.

Stand Option 1: Self-Supported Stand Kit #46-46128

Step 1

Slide the apron over the stand.

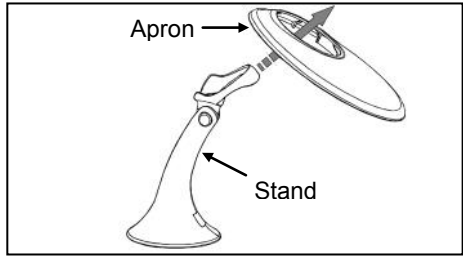

Figure 17.

Step 2

Position the stand so that it sits under the tab on the apron. Then secure the apron to the stand using the two M3 x 6 mm screws and the two #5 washers provided.

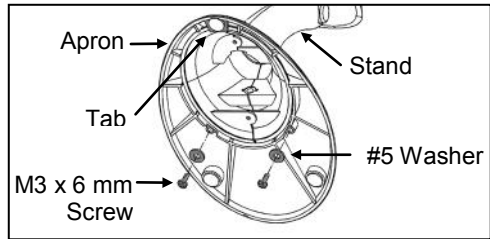

Figure 18.

Stand Option 2: Hard-Mount Accessory Kit #46-46351

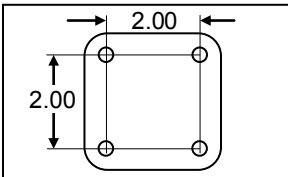

Figure 19.

Step 1

Drill four #39 holes in the countertop.

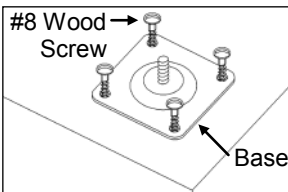

Figure 20.

Step 2

Secure the base to the countertop with the four #8 wood screws provided.

STAND KITS

Assembly

Stand Option 2: Hard-Mount Kits #46-46128 and #46-46351

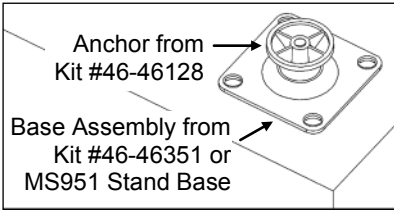

Figure 21.

Step 3

Screw the stand anchor onto the base assembly until it sits flush.

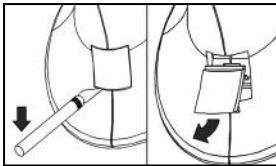

Figure 22.

Step 4

Remove the logo plate on the stand by gently using an exacto knife to release the plate hook.

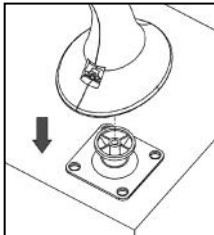

Figure 23.

Step 5

Position the stand over the base assembly.

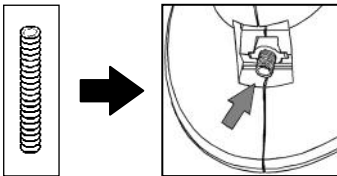

Figure 24.

Step 6

Secure the stand to the base assembly by installing and tightening the M3 set screw under the logo plate as shown.

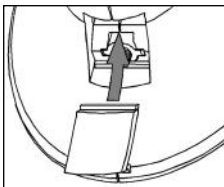

Figure 25.

Step 7

Snap the logo plate back into place.

Assembly

Wall Mount, Option 1:

For Kit #46-46508

Step 1

Drill two #39 pilot holes 3.00" apart.

Step 2

Attach the *Wall Mount Hanger* to the wall with the two #8 wood screws provided.

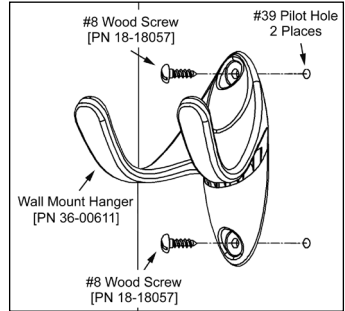

Figure 26.

Wall Mount, Option 2:

Kit #46-46508

Step 1

Attach the Wall Mount Base to the Wall Mount Hanger with the two 4.8 x 13 mm self-tapping screws.

Step 2

Remove one side of the protective backing from the double-sided adhesive tape.

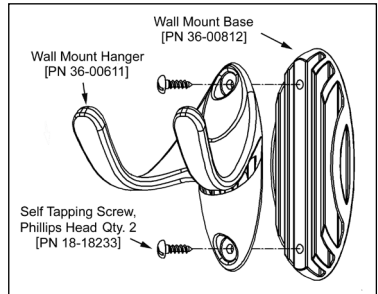

Figure 27.

Step 3

Attach the tape to the back of the Wall Mount Hanger as shown.

Step 4

Remove the protective backing from the double-sided adhesive tape and apply hook to the wall.

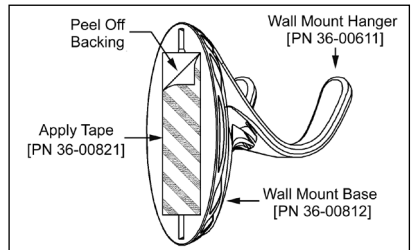

Figure 28.

Audible

When the Voyager is in operation, it provides audible feedback. These sounds indicate the status of the scanner. Eight settings are available for the tone of the beep (normal, six alternate tones and no tone). To change the beeper tone, refer to the MetroSelect Single-Line Configuration Guide or MetroSet2's help files.

One Beep

When the scanner *first* receives power, the green* LED will turn on, the red* LED will flash, and the scanner will beep once. The scanner is ready to scan.

When the scanner successfully reads a bar code, the red LED will flash and the scanner will beep once.

Three Beeps

During Operation

When entering the configuration mode, the red* LED will flash while the scanner simultaneously beeps three times.

When exiting the configuration mode, the scanner will beep three times and the red LED will stop blinking.

Three beeps can also indicate a communication timeout during normal scanning mode if the scanner is configured to give this indication.

During Start-up

This is a failure indicator. Refer to "Failure Modes" on page 19.

Three Beeps

When using the single-code-configuration method, the scanner will sound a 3-combination tone (a single beep then a short pause followed by, a high tone, and a low tone). This beep sequence signals that the single configuration bar code has successfully configured the scanner.

Razzberry Tone

On startup, this tone indicates a failure mode. Refer to "Failure Modes" on page 19.

When in configuration mode, a short razzberry tone will sound if an invalid bar code is scanned.

* In some *custom* units the standard green LED has been replaced with a blue LED and the red LED has been replaced with a white LED.

Visual

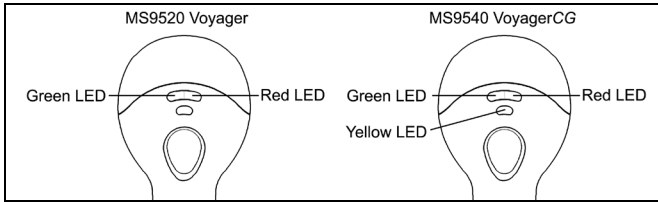

Figure 29. LED Configuration

The MS9540 has three LED indicators located on the head of the scanner. The MS9520 has two LED indicators located on the head of the scanner. When the scanner is in operation, the flashing, or stationary activity of the LEDs indicates the status of the scanner and the current scan.

All LEDs are Off

The LEDs will not be illuminated if the scanner is not receiving power from the host or transformer.

The scanner is in stand-by mode, and CodeGate is enabled. Present a bar code to the scanner and the green LED will turn on when the laser turns on.

Steady Yellow (*MS9540's Only*)

The CodeGate button is not active. If a bar code is in the scan field, the laser will turn on. The bar code will be decoded and transmitted to the host automatically.

Steady Green

When the laser is active, the green LED is illuminated. The green* LED will remain illuminated until the laser is deactivated (*default mode only*).

Steady Green and Single Red Flash

When the scanner successfully reads a bar code, the red* LED will flash and the scanner will beep once. If the red LED does not flash or the scanner does not beep once, then the bar code has not been successfully read (*default mode only*).



After a successful scan, the scanner transmits the data to the host device. Some communication modes require that the host inform the scanner when data is ready to be received. If the host is not ready to accept the information, the scanner's red LED will remain on until the data can be transmitted.

* In *some custom* units the standard green LED has been replaced with a blue LED and the red LED has been replaced with a white LED.

Failure Modes

Razzberry Tone – On Start-Up 📢🎵

This indicates the scanner has experienced a flipper/motor failure. Return the unit for repair to an authorized service center.

Continuous Razzberry Tone with all LEDs Off 📢🎵

If, upon power, the scanner emits a continuous razzberry tone, then the scanner has an experienced an electronic failure. Return the unit for repair to an authorized service center.

Three Beeps – on power up 📢🎵🎵

If the scanner beeps three times on power up then the non-volatile memory (NovRAM) that holds the scanner configuration has failed. If the scanner does not respond after reconfiguring, return the scanner for repair to an authorized service center.

CONFIGURATION MODES

The MS9500 Voyager has three modes of configuration.

- **Bar Codes**

The MS7120 can be configured by scanning the bar codes located in the MetroSelect Single-Line Configuration Guide. This manual is available for download at www.honeywellaidc.com.

- **MetroSet2**

This user-friendly Windows®-based configuration program allows you to simply 'point-and-click' at the desired scanner options. MetroSet2 is available for download at www.honeywellaidc.com.

- **Serial Configuration**

This mode of configuration is ideal for OEM applications. Serial programming mode gives the end-user the ability to send a series of commands using the serial port of the host system. The commands are equivalent to the numerical values of the bar codes located in the MetroSelect Configuration Guide.

How does Serial Configuration work?

1. Each command sent to the scanner is the ASCII representation of each numeral in the configuration bar code. The entire numeric string is framed with an ASCII [stx] and an ASCII [etx].

EXAMPLE #1:

Command for Disabling Codabar

Command = [stx]100104[etx]

String Sent to Scanner = 02h 31h 30h 30h 31h 30h 34h 03h

(All values are hexadecimal).

2. If the command sent to the scanner is valid, the scanner will respond with an [ack].
3. If the command sent to the scanner is invalid, the scanner will respond with a [nak].

NOTE: If this occurs, the end-user must start over at the very beginning of the configuration sequence. Re-transmitting the invalid command will not work, the user must start over.

CONFIGURATION MODES

4. During configuration, the motor and laser turn off. **YOU CANNOT SCAN A BAR CODE WHILE IN SERIAL CONFIGURATION MODE.**
5. There is a 20 second window between commands. If a 20 second timeout occurs, the scanner will send a [nak] and you must start over.
6. To enter serial configuration mode, send the following command [stx]999999[etx].
7. To exit serial configuration mode, send the following command [stx]999999[etx], the scanner will respond with an [ack] followed by 3 beeps.
8. This mode uses the current Baud Rate, Parity, Stop Bits and Data Bits settings that are configured in the scanner. The default settings of the scanner are 9600, Space, 2, 7 respectively. If a command is sent to the scanner to change any of these settings, the change will NOT take effect until after serial configuration mode is exited.

EXAMPLE #2:

The following example will set the scanner to the factory default settings, Disable Scanning of Code 128 bar codes, change the beeper tone, and add a "G" as a configurable prefix.

<u>FEATURE</u>	<u>HOST COMMAND</u>	<u>ASCII REPRESENTATION</u>	<u>SCANNER RESPONSE</u>
Enter Configuration Mode	[stx]999999[etx]	02h 39h 39h 39h 39h 39h 39h 03h	[ack] or 06h
Load Defaults	[stx]999998[etx]	02h 39h 39h 39h 39h 39h 38h 03h	[ack] or 06h
Disable Code 128	[stx]100113[etx]	02h 31h 30h 30h 31h 31h 33h 03h	[ack] or 06h
Alternate Tone 1	[stx]318565[etx]	02h 33h 31h 38h 35h 36h 35h 03h	[ack] or 06h
Configure. Prefix #1	[stx]903500[etx]	02h 39h 30h 33h 35h 30h 30h 03h	[ack] or 06h
Code Byte 0	[stx]0[etx]	02h 30h 03h	[ack] or 06h
Code Byte 7	[stx]7[etx]	02h 37h 03h	[ack] or 06h
Code Byte 1	[stx]1[etx]	02h 31h 03h	[ack] or 06h
Exit Configuration Mode	[stx]999999[etx]	02h 39h 39h 39h 39h 39h 39h 03h	[ack] or 06h

The scanner will beep three times!

The commands sent to the scanner do not include the small superscripted '3' that you see in front of each bar code string in the MetroSelect manual. **THE '3' SHOULD NOT BE SENT. IT IS A CODE TYPE DESIGNATION ONLY!**

As you will note for commands requiring additional bar codes to be scanned (such as prefixes, suffixes, timeouts, etc.), simply send the code bytes in the same order that you would normally scan the bar codes.

CONFIGURATION MODES

EXAMPLE #3:

The following example shows the events that occur when an invalid bar code is sent. This sample will load the factory default settings and then set the baud rate to 19200.

FEATURE	HOST COMMAND	ASCII REPRESENTATION	SCANNER RESPONSE
Enter Configuration Mode	[stx]999999[etx]	02h 39h 39h 39h 39h 39h 39h 03h	[ack] or 06h
Load Defaults	[stx]999999[etx]	02h 39h 39h 39h 39h 39h 3Ah 03h	[nak] or 15h
Invalid command was sent, you must start over!			
Enter Configuration Mode	[stx]999999[etx]	02h 39h 39h 39h 39h 39h 39h 03h	[ack] or 06h
Load Defaults	[stx]999998[etx]	02h 39h 39h 39h 39h 39h 39h 03h	[ack] or 06h
19200 Baud Rate	[stx]415870[etx]	02h 34h 31h 35h 38h 37h 30h 03h	[ack] or 06h
Exit Configuration Mode	[stx]999999[etx]	02h 39h 39h 39h 39h 39h 39h 03h	[ack] or 06h

The scanner will beep three times!

This example illustrates two important points.

First, if an invalid command is sent from the host, the scanner responds with a [nak] and the end-user must start over from the beginning.

Second, if a command is sent to change the Baud Rate, the new baud rate does not take effect until after the end-user exits configuration mode.

ABBREVIATED ASCII TABLE

Character	Hex Value	Decimal Value
[STX]	02h	2
[ETX]	03h	3
[ACK]	06h	6
[NAK]	15h	21
0	30h	48
1	31h	49
2	32h	50
3	33h	51
4	34h	52
5	35h	53
6	36h	54
7	37h	55
8	38h	56
9	39h	57

UPGRADING THE FIRMWARE

The Voyager series is part of Honeywell's line of scanners with flash upgradeable firmware. The upgrade process requires a new firmware file supplied to the customer by a customer service representative♦ and MetroSet2 software♦♦. A personal computer running Windows 95 or greater with an available RS232 serial or USB port is required to complete the upgrade.



Do not use the standard cable supplied with Keyboard Wedge or RS485 interface kits for firmware upgrades. Use either cable #54-54014x or #53-53014x. If using USB or RS232 for the upgrade process, the standard USB or RS232 cable provided with the scanner can be used.

To upgrade the firmware in the MS9520/MS9540:

1. Plug the scanner into a serial communication port on the host system.
2. Start the MetroSet2 software.
3. Click on the plus sign (+) next to *POS Scanners* to expand the supported scanner list.
4. Choose the *Voyager/9520 N/R* or *Voyager/9540 N/R* from the list.
5. Click on the Configure Scanner button.
6. Choose *Flash Utility* from the options list located on the left side of the screen.
7. Click on the *Open File* button in the Flash Utility window.
8. Locate and open the flash upgrade file supplied.
9. Select the COM port that the scanner is connected to on the host system.
10. Verify the settings listed in the Flash Utility window.
11. Click on the *Flash Scanner* button to begin the flash upgrade.
12. A message will appear on the screen when the upgrade is complete.

- ♦ See Customer Support on page 42.
- ♦♦ MetroSet2 is available for download, at no additional cost, from www.honeywellaidc.com

DEPTH OF FIELD

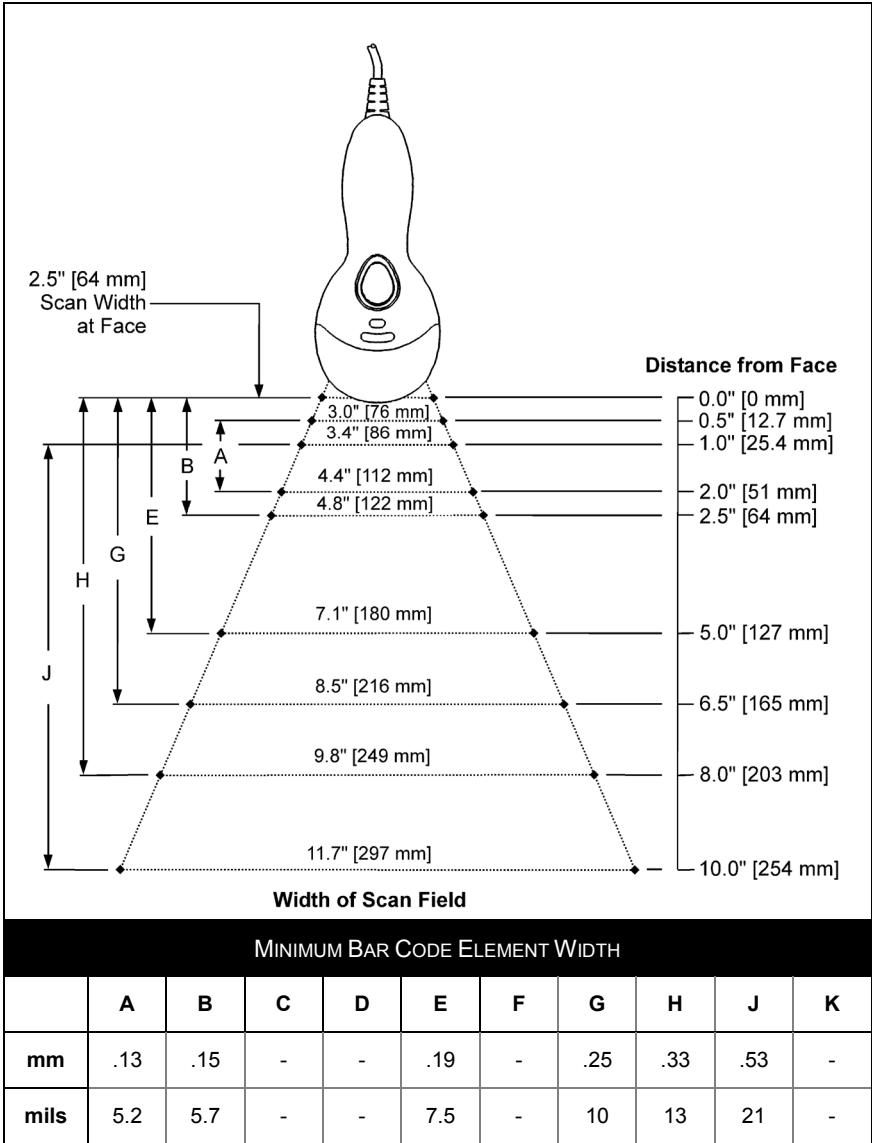

Figure 30. Depth of Field

IR ACTIVATION RANGE

The scanner's laser will turn off if the scanner has been idle. When the scanner's IR detects movement in the activation area (see figure below), the laser will automatically turn on, preparing the scanner for bar code recognition, decoding, and transmission. The default laser/scan mode for the MS9500 series is *normal scan*.

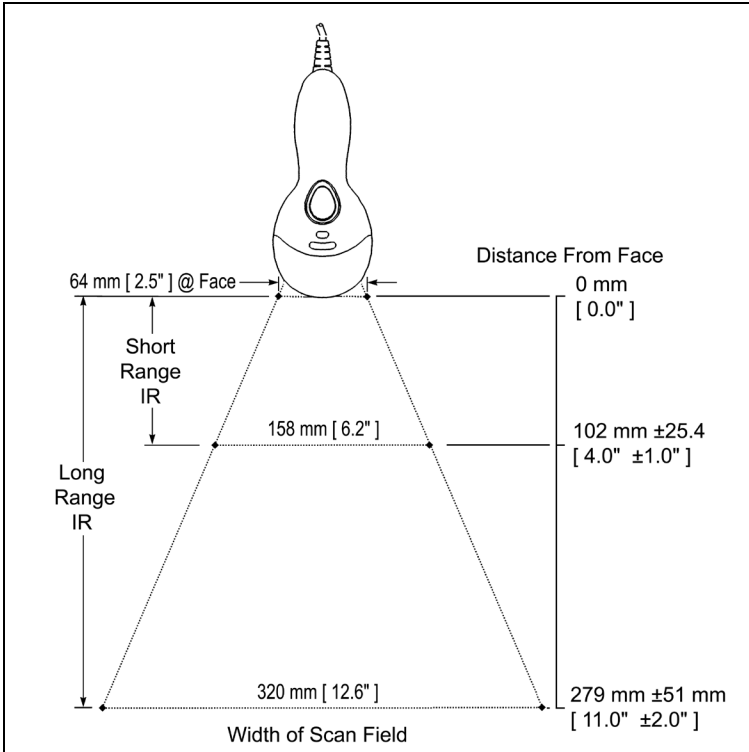

Figure 31. Short and Long IR Activation Area

APPLICATIONS AND PROTOCOLS

The model number on each scanner includes the scanner number and factory default communication protocol.

Scanner	Version Identifier	Communication Protocol(s)
MS9520	00	Laser Emulation and RS232 Transmit/Receive
	11	RS485, RS232 - TXD, RXD, RTS, CTS
	14	RS232 - TXD, RXD, RTS, CTS, DTR, DSR
Or	38	Low Speed USB, Serial Emulation or Keyboard Emulation
MS9540	40	Full Speed Integrated USB
	41	RS232/Light Pen Emulation
	47	Keyboard Wedge, Stand-Alone Keyboard and TTL RS232 Transmit/Receive

The MS9520/9540 Keyboard Wedge Series (-47) is designed for keyboard emulation only. Many RS232 configurable functions available in other Honeywell scanners are also available as keyboard wedge functions.

The following are the most important selectable options specific to keyboard wedge:

Keyboard Type

- **AT (includes IBM® PS2 models 50, 55, 60, 80)
- IBM PS2 (includes models 30, 70, 8556)

Keyboard Country Type

- | | | |
|-------------|--------------------|-------------------|
| • **USA | • Italian | • Swiss |
| • Belgian | • Japanese | • Swedish/Finnish |
| • French | • Russian Cyrillic | • Turkish |
| • German | • Slovenian | • United Kingdom |
| • Hungarian | • Spanish | |

** Default setting. Refer to the MetroSelect® Configuration Guide (PN 00-02407) or MetroSet2's help files for information on how to change the default settings.

TROUBLESHOOTING GUIDE

The following guide is for reference purposes only. Contact a customer service representative to preserve the limited warranty terms on page 36.

Symptoms	Possible Causes	Solution
<i>All Interfaces</i>		
The unit has no LEDs, beep or laser.	No power is being supplied to the unit.	Check the transformer, the outlet and power strip. Make sure the cable is plugged into the unit.
	No power is being supplied to the unit from host.	Some host systems cannot supply enough current to power Voyager. A power supply may be needed.
At power up the unit beeps 2 times and alternately flashes the LEDs.	There is a ROM failure.	A flash ROM upgrade is required.
At power up the unit beeps 3 times.	There is a non-volatile RAM failure.	Contact a customer service representative.
At power up there is a continuous razz tone.	There has been a diagnostic failure.	
At power up there is a razz tone and the green* LED flashes.	There is a VLD failure.	
At power up there is a razz tone and both LEDs flash.	There is a scanning mechanism failure.	
The unit scans, communicates, and beeps twice.	The same symbol timeout is set too short.	Adjust the same symbol timeout for a longer time.
The unit powers up, but does not beep.	The beeper may be disabled or no tone has been selected.	Enable beeper and select a tone.
The unit powers up, but does not scan and/or beep.	The unit is trying to scan a particular symbology that is not enabled.	UPC/EAN, Code 39, interleaved 2 of 5, Code 93, Code 128 and Codabar are enabled by default. Verify that the type of bar code being read has been selected.
* In some custom units, the standard green LED has been replaced with a blue LED and the red LED has been replaced with a white LED.		

TROUBLESHOOTING GUIDE

Symptoms	Possible Causes	Solution
The unit powers up, but does not scan and/or beep.	The bar code being scanned does not satisfy the configured criteria for character length lock or minimum length.	Verify that the bar code being scanned falls into the configured criteria. <i>The scanner defaults to a minimum of 3 character bar code.</i>
<i>The following item is only relevant for TTL RS232 and Serial Emulation USB interfaces.</i>		
The unit scans a bar code, but locks up after the first scan and the red* LED stays on.	The unit is configured to support some form of host handshaking but is not receiving the signal.	If the unit is setup to support ACK/NAK, RTS/CTS, XON/XOFF or D/E, verify that the host cable and host are supporting the handshaking properly.
The unit scans, but the data transmitted to the host is incorrect.	The unit's data format does not match the host system's requirements.	Verify that the unit's data format matches that required by the host. Make sure that the unit is connected to the proper host port.
The unit beeps at some bar codes but NOT for others of the same bar code symbology.	The bar code may have been printed incorrectly.	Check if it is a check digit/character or border problem.
	The unit is not configured correctly for the type of bar code being scanned.	
	The minimum symbol length setting does not work with the bar code.	Check if the correct minimum symbol length is set.
The unit scans the bar code but there is no data.	The unit's configuration is not correct.	Make sure the scanner is configured for the appropriate mode.
The host is receiving data but the data does not look correct.	The scanner and host may not be configured for the same interface parameters.	Check that the scanner and the host are configured for the same interface parameters.
Characters are being dropped.	Inter-character delay needs to be added to the transmitted output.	Add some inter-character delay to the transmitted output by using the MetroSelect Single-Line Configuration Guide.
* <i>In some custom units, the standard green LED has been replaced with a blue LED and the red LED has been replaced with a white LED.</i>		

TROUBLESHOOTING GUIDE

Symptoms	Possible Causes	Solution
<i>The following four items are relevant for a Keyboard Wedge interface only.</i>		
The unit scans but the data is not correct.	The unit's configuration is not correct.	Make sure that the proper PC type AT, PS2 or XT is selected. Verify the correct country code and data format is selected. Adjust the inter-character delay symptom.
The unit is transmitting each character twice.	The unit's configuration is not correct.	Increase the interscan code delay setting. Adjust whether the F0 break is transmitted. It may be necessary to try this in both settings.
Alpha characters show as lower case.	The computer is in <i>Caps Lock</i> mode.	Enable the <i>Caps Lock</i> detect feature of the scanner to detect whether the PC is operating in Caps Lock.
Everything works except for a couple of characters.	These characters may not be supported by that country's key look up table.	Try operating the scanner in Alt mode.
<i>The following item is relevant for an RS232 interface only.</i>		
The unit will power-up and scan but does not communicate properly to the host.	The com port at the host is not working or not configured properly.	Check to make sure that the baud rate and parity of the scanner and the communication port match and that the program is looking for "RS232" data.
The unit will power-up and scan but does not communicate properly to the host.	The cable is not connected to the proper com port.	Check to make sure that the unit is connected to the correct com port on the host device.

DESIGN SPECIFICATIONS

OPERATIONAL		
Light Source	Visible Laser Diode 650 nm	
Laser Power:	Less than 1 mW (peak)	
Embedded Laser:	Max Power: 10 mW	
	Wavelength: 650 nm	
Depth of Scan Field:	0 mm - 203 mm (0" - 8") for 0.330 mm (13 mil) bar code at default settings	
Scan Speed:	72 scan lines per second	
Scan Pattern:	Single scan line	
Minimum Bar Width:	0.127 mm (5.0 mil)	
Infrared Activation:	Long Range: 0 mm – 279 mm ± 51 mm (0" – 11" ± 2")	
	Short Range: 0 mm – 102 mm ± 25 mm (0" – 4" ± 1")	
Decode Capability:	Autodiscriminates all standard bar codes for others call a customer service representative	
System Interfaces:	RS232, PC Keyboard Wedge, Stand-Alone Keyboard, RS485, Light Pen Emulation, Laser Emulation, RS232 with DSR, Low Speed USB (<i>Serial Emulation or Keyboard Emulation</i>), Full Speed USB	
Print Contrast:	35% minimum reflectance difference	
Number Characters Read:	Up to 80 data characters (<i>Maximum number will vary based on symbology & density</i>)	
Roll, Pitch, Yaw:	42°, 68°, 52°	
Beeper Operation:	7 tones or no beep	
Visual Indicators: <i>Default Settings</i>	Green* LED	laser on, ready to scan
	Red* LED	good read
	Yellow LED (MS9540 Only)	ON, CodeGate button is inactive
		OFF, CodeGate button is active
* In some <i>custom</i> units, the standard green LED has been replaced with a blue LED and the red LED has been replaced with a white LED.		

Specifications are subject to change without notice.

DESIGN SPECIFICATIONS

MECHANICAL	
Length:	198 mm (7.8")
Width:	Handle - 45 mm (1.8"), Head - 78 mm (3.1")
Depth:	40 mm (1.6")
Weight:	149 g (5.25 oz)
ELECTRICAL	
Input Voltage:	5VDC \pm 0.25V
Power:	Operating = 0.825 W <i>typical</i>
	Standby = 0.600 W <i>typical</i>
Current:	Operating = 165 mA @ 5VDC <i>typical</i>
	Standby = 120 mA @ 5VDC <i>typical</i>
DC Transformers:	Class 2; 5.2V @ 1A
<i>For regulatory compliance information see pages 37 – 39.</i>	
ENVIRONMENTAL	
Temperature:	Operating = 0°C to 40° (32° to 104°F) Storage = -40°C to 60°C (-40°F to 140°F)
Humidity:	5% to 95% relative humidity, non-condensing
Light Levels:	Up to 4842 Lux (450 footcandles)
Shock:	Designed to withstand 1.5 m (5 ft.) drops
Contaminants:	Sealed to resist airborne particulate contaminants
Ventilation:	None required

Specifications are subject to change without notice.

SCANNER AND CABLE TERMINATIONS

Scanner Pinout Connections

The MS9520 and MS9540 scanner interfaces terminate to a 10-pin modular jack. The serial number label indicates the interface enabled when the scanner is shipped from the factory.

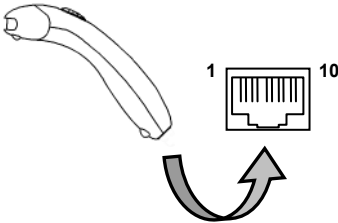

MS95x0-41 RS232 and Light Pen Emulation	
Pin	Function
1	Ground
2	RS232 Transmit Output
3	RS232 Receive Input
4	RTS Output
5	CTS Input
6	DTR Input/LTPN Source
7	Reserved
8	LTPN Data
9	+5VDC
10	Shield Ground

MS95x0-47 Keyboard Wedge and Stand-Alone Keyboard	
Pin	Function
1	Ground
2	TTL RS232 Transmit Output
3	TTL RS232 Receive Input
4	PC Data
5	PC Clock
6	KB Clock
7	PC +5V
8	KB Data
9	+5VDC
10	Shield Ground

MS95x0-11 RS485	
Pin	Function
1	Ground
2	RS232 Transmit Output
3	RS232 Receive Input
4	RTS Output
5	CTS Input
6	DTR Input
7	IBM B-Transmit
8	IBM A+ Receive
9	+5VDC
10	Shield Ground

SCANNER AND CABLE TERMINATIONS

Scanner Pinout Connections

MS95.x0-00 Laser Emulation	
Pin	Function
1	Ground
2	RS232 Transmit Output
3	RS232 Receive Input
4	Flip Sense/Start of Scan Output
5	Proximity Detect/Trigger Emulation Output
6	Scan/Laser Enable Input
7	Reserved
8	Data Out
9	+5VDC
10	Shield Ground



MS95.x0-14 RS232	
Pin	Function
1	Ground
2	RS232 Transmit Output
3	RS232 Receive Input
4	RTS Output
5	CTS Input
6	DTR Input
7	Reserved
8	DSR Out
9	+5VDC
10	Shield Ground

MS95.x0-40 Full Speed USB & MS95.x0-38 Low Speed USB	
Pin	Function
1	Ground
2	RS232 Transmit Output
3	RS232 Receive Input
4	RTS Output
5	CTS Input
6	D+
7	PC +5V/V_USB
8	D-
9	N/C
10	Drain Wire

SCANNER AND CABLE TERMINATIONS

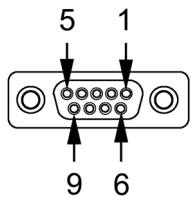
Cable Connector Configuration (Host End)

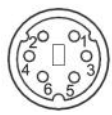

RS232 PowerLink Cable PN 53-53000.x-3		
Pin	Function	 <p>9-Pin Female, D-Type</p>
1	Shield Ground	
2	TTL RS232 Transmit Output	
3	TTL RS232 Receive Input	
4	DTR Input/Light Pen Source	
5	Signal Ground	
6	Light Pen Data (DSR Out for -14 interfaces)	
7	CTS Input	
8	RTS Output	
9	+5VDC	

USB Cables PN 53-53213.x-N-3, 53-53214.x-N-3 or 53-53235.x-N-3			
Pin	Function	 <p>Locking Type A</p>	 <p>Non-Locking Type A</p>
1	PC +5V/V_USB		
2	D-		
3	D+		
4	Ground		
Shield	Shield		

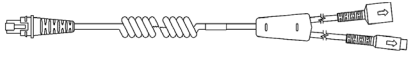

Stand-Alone Keyboard PowerLink Cable PN 53-53020.x-3		
Pin	Function	 <p>6-Pin Male Mini-DIN Connector</p>
1	PC Data	
2	NC	
3	Power Ground	
4	+5VDC PC Power to KB	
5	PC Clock	
6	NC	

SCANNER AND CABLE TERMINATIONS

Cable Connector Configuration (Host End)

Keyboard Wedge PowerLink Cable PN 53-53002X-3		
Pin	Function	 5-Pin DIN, Female
1	Keyboard Clock	
2	Keyboard Data	
3	No Connect	
4	Power Ground	
5	+5 Volts DC	
Pin	Function	 6-Pin DIN, Male
1	PC Data	
2	No Connect	
3	Power Ground	
4	+5 Volts DC	
5	PC Clock	
6	No Connect	

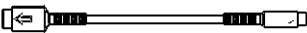
Honeywell will supply an adapter cable with a 5-pin DIN male connector on one end and a 6-pin mini DIN female connector on the other. According to the termination required, connect the appropriate end of the adapter cable to the PowerLink cable, leaving the necessary termination exposed for connecting to the keyboard and the keyboard port on the PC.

Keyboard Wedge Adapter Cable		
Pin	Function	 5-Pin DIN, Male
1	PC Clock	
2	PC Data	
3	No Connect	
4	Power Ground	
5	+5 Volts DC	
Pin	Function	 6-pin Mini DIN, Female
1	Keyboard Data	
2	No Connect	
3	Power Ground	
4	+5 Volts DC	
5	Keyboard Clock	
6	No Connect	

LIMITED WARRANTY

Honeywell International Inc. ("HII") warrants its products and optional accessories to be free from defects in materials and workmanship and to conform to HII's published specifications applicable to the products purchased at the time of shipment. This warranty does not cover any HII product which is (i) improperly installed or used; (ii) damaged by accident or negligence, including failure to follow the proper maintenance, service, and cleaning schedule; or (iii) damaged as a result of (A) modification or alteration by the purchaser or other party, (B) excessive voltage or current supplied to or drawn from the interface connections, (C) static electricity or electro-static discharge, (D) operation under conditions beyond the specified operating parameters, or (E) repair or service of the product by anyone other than HII or its authorized representatives.

This warranty shall extend from the time of shipment for the duration published by HII for the product at the time of purchase ("Warranty Period"). Any defective product must be returned (at purchaser's expense) during the Warranty Period to HII factory or authorized service center for inspection. No product will be accepted by HII without a Return Materials Authorization, which may be obtained by contacting HII. In the event that the product is returned to HII or its authorized service center within the Warranty Period and HII determines to its satisfaction that the product is defective due to defects in materials or workmanship, HII, at its sole option, will either repair or replace the product without charge, except for return shipping to HII.

EXCEPT AS MAY BE OTHERWISE PROVIDED BY APPLICABLE LAW, THE FOREGOING WARRANTY IS IN LIEU OF ALL OTHER COVENANTS OR WARRANTIES, EITHER EXPRESSED OR IMPLIED, ORAL OR WRITTEN, INCLUDING, WITHOUT LIMITATION, ANY IMPLIED WARRANTIES OF MERCHANTABILITY OR FITNESS FOR A PARTICULAR PURPOSE, OR NON-INFRINGEMENT.

HII'S RESPONSIBILITY AND PURCHASER'S EXCLUSIVE REMEDY UNDER THIS WARRANTY IS LIMITED TO THE REPAIR OR REPLACEMENT OF THE DEFECTIVE PRODUCT WITH NEW OR REFURBISHED PARTS. IN NO EVENT SHALL HII BE LIABLE FOR INDIRECT, INCIDENTAL, OR CONSEQUENTIAL DAMAGES, AND, IN NO EVENT, SHALL ANY LIABILITY OF HII ARISING IN CONNECTION WITH ANY PRODUCT SOLD HEREUNDER (WHETHER SUCH LIABILITY ARISES FROM A CLAIM BASED ON CONTRACT, WARRANTY, TORT, OR OTHERWISE) EXCEED THE ACTUAL AMOUNT PAID TO HII FOR THE PRODUCT. THESE LIMITATIONS ON LIABILITY SHALL REMAIN IN FULL FORCE AND EFFECT EVEN WHEN HII MAY HAVE BEEN ADVISED OF THE POSSIBILITY OF SUCH INJURIES, LOSSES, OR DAMAGES. SOME STATES, PROVINCES, OR COUNTRIES DO NOT ALLOW THE EXCLUSION OR LIMITATIONS OF INCIDENTAL OR CONSEQUENTIAL DAMAGES, SO THE ABOVE LIMITATION OR EXCLUSION MAY NOT APPLY TO YOU.

All provisions of this Limited Warranty are separate and severable, which means that if any provision is held invalid and unenforceable, such determination shall not affect the validity of enforceability of the other provisions hereof. Use of any peripherals not provided by the manufacturer may result in damage not covered by this warranty. This includes but is not limited to: cables, power supplies, cradles, and docking stations. HII extends these warranties only to the first end-users of the products. These warranties are non-transferable.

The duration of the limited warranty for the MS9500 is five (5) year(s). The accessories have a 90 day limited warranty from the date of manufacture.

Safety

ITE Equipment

IEC 60950-1 Second Edition
EN 60950-1 Second Edition



Laser

Laser Class 1: IEC 60825-1: Second Edition 2007
EN 60825-1: Second Edition 2007

Complies with 21 CFR 1040.10 and 1040.11 except for deviations pursuant to Laser Notice No. 50, dated June 24, 2007.

LED

IEC 62471: Exempt Risk Group

Caution

Use of controls or adjustments or performance of procedures other than those specified herein may result in hazardous laser light exposure. Under no circumstances should the customer attempt to service the laser scanner. Never attempt to look at the laser beam, even if the scanner appears to be nonfunctional. Never open the scanner in an attempt to look into the device. Doing so could result in hazardous laser light exposure. The use of optical instruments with the laser equipment will increase eye hazard.

Atención

La modificación de los procedimientos, o la utilización de controles o ajustes distintos de los especificados aquí, pueden provocar una luz de láser peligrosa. Bajo ninguna circunstancia el usuario deberá realizar el mantenimiento del láser del escáner. Ni intentar mirar al haz del láser incluso cuando este no esté operativo. Tampoco deberá abrir el escáner para examinar el aparato. El hacerlo puede conllevar una exposición peligrosa a la luz de láser. El uso de instrumentos ópticos con el equipo láser puede incrementar el riesgo para la vista.

Attention

L'emploi de commandes, réglages ou procédés autres que ceux décrits ici peut entraîner de graves irradiations. Le client ne doit en aucun cas essayer d'entretenir lui-même le scanner ou le laser. Ne regardez jamais directement le rayon laser, même si vous croyez que le scanner est inactif. N'ouvrez jamais le scanner pour regarder dans l'appareil. Ce faisant, vous vous exposez à une rayonnement laser qui est dangereux. L'emploi d'appareils optiques avec cet équipement laser augmente le risque d'endommagement de la vision.

Achtung

Die Verwendung anderer als der hier beschriebenen Steuerungen, Einstellungen oder Verfahren kann eine gefährliche Laserstrahlung hervorrufen. Der Kunde sollte unter keinen Umständen versuchen, den Laser-Scanner selbst zu warten. Sehen Sie niemals in den Laserstrahl, selbst wenn Sie glauben, daß der Scanner nicht aktiv ist. Öffnen Sie niemals den Scanner, um in das Gerät hineinzusehen. Wenn Sie dies tun, können Sie sich einer gefährlichen Laserstrahlung aussetzen. Der Einsatz optischer Geräte mit dieser Laserausrüstung erhöht das Risiko einer Sehschädigung.

Attenzione

L'utilizzo di sistemi di controllo, di regolazioni o di procedimenti diversi da quelli descritti nel presente Manuale può provocare delle esposizioni a raggi laser rischiose. Il cliente non deve assolutamente tentare di riparare egli stesso lo scanner laser. Non guardate mai il raggio laser, anche se credete che lo scanner non sia attivo. Non aprite mai lo scanner per guardare dentro l'apparecchio. Facendolo potete esporVi ad una esposizione laser rischiosa. L'uso di apparecchi ottici, equipaggiati con raggi laser, aumenta il rischio di danni alla vista.

EMC

Emissions

FCC Part 15, ICES-003, CISPR 22, EN 55022

Immunity

CISPR 24, EN 55024

Note: Immunity performance is not guaranteed for scanner cables greater than 3 meters in length when fully extended.

Changes or modifications not expressly approved by the party responsible for compliance could void the user's authority to operate the equipment.

Class A Devices

The following is applicable when the scanner cable is greater in length than 3 meters (9.8 feet) when fully extended:

Les instructions ci-dessous s'appliquent aux cables de scanner dépassant 3 mètres (9.8 pieds) de long en extension maximale:

Folgendes trifft zu, wenn das Scannerkabel länger als 3 Meter ist:

This equipment has been tested and found to comply with limits for a Class A digital device, pursuant to part 15 of the FCC Rules. These limits are designed to provide reasonable protection against harmful interference when the equipment is operated in a commercial environment. This equipment generates, uses, and can radiate radio frequency energy and, if not installed and used in accordance with the instruction manual, may cause harmful interference to radio communications. Operation of this equipment in a residential area is likely to cause harmful interference, in which case the user will be required to correct the interference at their own expense. Any unauthorized changes or modifications to this equipment could void the user's authority to operate this device.

This device complies with part 15 of the FCC Rules. Operation is subject to the following two conditions: (1) This device may not cause harmful interference, and (2) this device must accept any interference received, including interference that may cause undesired operation.

Notice

This Class A digital apparatus complies with Canadian ICES-003.

Remarque

Cet appareil numérique de classe A est conforme à la norme canadienne NMB-003.

Warning

This is a class A product. In a domestic environment this product may cause radio interference in which case the user may be required to take adequate measures.

REGULATORY COMPLIANCE

Warnung!

Dies ist eine Einrichtung der Klasse A. Diese Einrichtung kann im Wohnbereich Funkstörungen verursachen. In diesem Fall kann vom Betreiber verlangt werden, angemessene Massnahmen durchzuführen.

Attenzione

Questo e' un prodotto di classe A. Se usato in vicinanza di residenze private potrebbe causare interferenze radio che potrebbero richiedere all'utilizzatore opportune misure.

Attention

Ce produit est de classe "A". Dans un environnement domestique, ce produit peut être la cause d'interférences radio. Dans ce cas l'utilisateur peut être amené à prendre les mesures adéquates.

Changes or modifications not expressly approved by the party responsible for compliance could void the user's authority to operate the equipment.

Class B Devices

The following is applicable when the scanner cable is less than 3 meters (9.8 feet) in length when fully extended:

Les instructions ci-dessous s'appliquent aux cables de scanner ne dépassant pas 3 mètres (9.8 pieds) de long en extension maximale:

Folgendes trifft zu, wenn das Scannerkabel kürzer als 3 Meter ist:

This device complies with Part 15 of the FCC Rules. Operation is subject to the following two conditions: (1) This device may not cause harmful interference, and (2) this device must accept any interference received, including interference that may cause undesired operation.

This equipment has been tested and found to comply with the limits for a Class B digital device, pursuant to Part 15 of the FCC rules. These limits are designed to provide reasonable protection against harmful interference in a residential installation. This equipment generates, uses, and can radiate radio frequency energy and, if not installed and used in accordance with the instructions, may cause harmful interference to radio communications. However, there is no guarantee that interference will not occur in a particular installation. If this equipment does cause harmful interference to radio or television reception, which can be determined by turning the equipment off and on, the user is encouraged to try to correct the interference by one or more of the following measures:

- Reorient or relocate the receiving antenna
- Increase the separation between the equipment and receiver
- Connect the equipment into an outlet on a circuit different from that to which the receiver is connected
- Consult the dealer or an experienced radio/TV technician for help

Notice

This Class B digital apparatus complies with Canadian ICES-003.

Remarque

Cet appareil numérique de classe B est conforme à la norme canadienne NMB-003.

INDEX

A

AC *see power*
accessories 2, 3
adapter 2

C

cable 2–3, 27–29
 adapter 2
 communication 1, 2–3, 5, 7–11, 29, 32–35
 disconnect 5
 MVC 3, 8
 pin assignments 32–35
caution 6, 37
 labels 6
 laser 6
CE *see caution*
CodeGate 1, 12, 18
communication 27–29
compliance 37–39
configuration 20, 21, 26
converter 3
current 31
customer service 36

D

default 21, 22, 26
depth of field 24

E

EMC 38
EMI 38
emissions 38

F

firmware 23

G

green LED *see indicator*

I

IBM *see interface: RS485*
immunity 38
indicator
 audible 21, 30

 failure 27–29
 visual 4, 27–29, 30
interface 30, 32–35
 Keyboard Wedge. 1, 9, 26, 32, 35
 Laser Emulation 1, 7, 26, 33
 Light Pen 1, 7, 26, 32
 RS232 1, 7, 26, 29, 33, 34
 RS485 1, 8, 26, 32
 Stand Alone Keyboard . 1, 10, 32, 34
 USB 1, 11, 26, 33, 34
IR range 25

K

Keyboard Wedge *see interface*

L

labels 6
laser 30, 37–39, 37
laser emulation *see interface*
LED *see indicator*
light level 31
Light Pen *see interface*

M

maintenance 6
manual 2

O

output window 4

P

pin assignments *see cable*
power 2, 7–11, 31
PowerLink 35, *see cable*
protocols *see interface*

R

Red LED *see indicator*
regulatory compliance 37–39
repair 36
RMA 36
RS232 *see interface*
RS485 *see interface*

INDEX

S

safety.....37
SELV..... *see caution*
serial number.....6
specifications.....30, 31
stand.....3, 13–16

T

termination.....32–35
troubleshooting.....27–29

U

UL..... *see caution*
USB..... *see interface*

V

ventilation.....31
voltage.....2, 31, *see caution*

W

warranty.....36
window.....4, 6

Technical Assistance

If you need assistance installing or troubleshooting your device, please contact us by using one of the methods below:

Knowledge Base: www.hsmknowledgebase.com

Our Knowledge Base provides thousands of immediate solutions. If the Knowledge Base cannot help, our Technical Support Portal (see below) provides an easy way to report your problem or ask your question.

Technical Support Portal: www.hsmsupportportal.com

The Technical Support Portal not only allows you to report your problem, but it also provides immediate solutions to your technical issues by searching our Knowledge Base. With the Portal, you can submit and track your questions online and send and receive attachments.

Web form: www.hsmcontactsupport.com

You can contact our technical support team directly by filling out our online support form. Enter your contact details and the description of the question/problem.

Telephone: www.honeywellaidc.com/locations

For our latest contact information, please check our website at the link above.

Product Service and Repair

Honeywell International Inc. provides service for all of its products through service centers throughout the world. To obtain warranty or non-warranty service, please visit www.honeywellaidc.com and select **Support > Contact Service and Repair** to see your region's instructions on how to obtain a Return Material Authorization number (RMA #). You should do this prior to returning the product

Honeywell Scanning & Mobility
9680 Old Bailes Road
Fort Mill, SC 29707
www.honeywellaidc.com

